

TripMate850

User's Manual



Published on 22-April-2010

Note and Warning

- **TripMate850 uses AAA battery*2. If TripMate850 is used in temperature lower than -10°C or higher than 60°C, the battery capability will decrease. Please leave TripMate850 far from heat or high temperature environment. In addition, do not expose your TripMate850 in temperature higher than 140°C/60°C. If you do not follow these rules, the battery may become heat, explode or burn itself, and this will lead to very serious damage.**
- **While in the hospital, turn off TripMate850 is recommended. Like other common equipments do, wireless GPS receiver may also interfere medical equipments which use radio frequency.**
- **Remove batteries from TripMate850 when not using it for a long period of time.**
- **Keep TripMate850 and all accessories out of small children's reach for safety caution.**
- **We assume no responsibility for any damage and loss resulting from the use of this manual and also by deletion of data as a result of malfunction, dead battery, or misuse of the product in any way.**
- **Use only the supplied and approved accessories. Unauthorized accessories, antenna, modifications or attachments could damage TripMate850, and may violate regulations governing radio devices.**
- **Use a dry, clean soft cloth to clean your TripMate850. Do not use harsh cleaning solvents, chemicals, or strong detergents.**
- **Do not attempt to open TripMate850 by yourself. Unauthorized hacking may damage the unit, and void your warranty.**

Table of Contents

Chapter1. Before you begin	4
1.1 Introduction	4
1.2 Feature Overview	4
1.3 Specifications	4
1.4 Buttons and Description	6
1.5 Accessories	6
Chapter2. Getting Started	7
2.1 Turn on/off TripMate850	7
2.2 Main Flow	7
2.3 Flow Diagram	8
2.4 ICON Introduction	9
2.5 Functional description	10
2.5.1 Battery, Satellite, Log memory Mode	10
2.5.2 Time Mode	11
2.5.3 Position Mode	11
2.5.4 Speed & Direction Mode	11
2.5.5 Distance Measurement Mode	12
2.5.6 Track Back to POI	13
2.5.7 Setting Mode	14
2.5.7.1 Several Language Setting	14
2.5.7.2 Log Mode Setting	15
2.5.7.3 Smart Log Setting	16
2.5.7.4 Log Manage Setting	17
2.5.7.5 Unit Set	18
2.5.7.6 Backlight Set	18
2.5.7.7 Sensor Set	19
2.5.7.8 Log File Size Set	19
2.5.7.9 Default Set	20
2.5.7.10 AP VERSION	20
2.5.8 Connecting with your handheld device	21
2.6 AP upgrade	23
2.7 Helpful Tips	25
Chapter3. How to configure your GPS Record?	26
3.1 GpsView software	26
3.1.1 Using GpsView Program	26
3.2 Download AGPS	26
Chapter4. Using Photo Tagger software	29
4.1 Execute and install software utility Photo Tagger	29
4.2 Google Earth	29

4.3	Software Utility - TripMate850	29
Chapter5.	Power description	29
Appendix A.	Locr GPS Photo	30
Appendix B.	Certification	31
Appendix C.	Warranty Information	33

Chapter1. Before you begin

1.1 Introduction

TripMate850 features an all-in-one, cost-effective portable GPS logger solution. When you travel in different country, it allows you to record your routes by ways of time/ distance/ speed. The TripMate850 includes a one inch LCD, as the real time, moving speed, distance measurement and position information, all of the message always can be shown on the screen. Through user friendly software utility, it can combine your pictures and record routes, and show on the map. This recorder is small and robust, ideal to carry everywhere for applications such as route tracking, mountain climbing or fleet management.

1.2 Feature Overview

- ⊙ MTK 3329 chip
- ⊙ Smart log function
- ⊙ Receiver & data logger dual function design
- ⊙ Track back function
- ⊙ Vibration sensor for power saving
- ⊙ Micro SD card for unlimited storage
- ⊙ 1" LCD easy display
- ⊙ Support AGPS
- ⊙ Powered by AAA battery*2

1.3 Specifications

General			
Frequency	L1,1575.42MHz	C/A Code	1.023Mhz
Datum	WGS84		
Performance Characteristics			
Position Accuracy	Without aid: 3.0m 2D-RMS	Velocity Accuracy	Without aid: 0.1m/s
	<3m CEP(50%) without SA(horizontal)		DGPS(WAAS,EGNOS,MSAS): 0.05m/s
Timing Accuracy	DGPS(WAAS,EGNOS,MSAS): 2.5m	Acceleration	Without aid: <4g
	50ns RMS		DGPS(WAAS,EGNOS,MSAS): <4g
Reacquisition Time	<1s	Hot start	1.5s

Warm start	34s	Cold start	35s
AGPS	<15s	Sensitivity	Acquisition: -148dBm Max.
Update	1Hz		Tracking: -165dBm Max.
Dynamic			
Altitude	Maximum 18,000m	Acceleration	Maximum 4g
Velocity	Maximum 515m/s		
Power			
Operation Time	Up to 12 hours	Battery	AAA battery*2
I/O			
Baudrate	115200 bps	Protocol	NMEA 0183 v3.01
LCD			
Size	28 x 8.5mm	Pixel	128 x 32 pixel
Environment			
Operation Temperature	-10° to 50°		
Interface			
USB Bridge	Fully compliant with USB2.0	Bluetooth	Fully compliant with Bluetooth V1.2
	12Mbps		
SD	Micro SD card		Up to 10 meters
			Serial Port Profile(SPP)
			2.4GHz~2.4835GHz ISM Band
Others			
Weight (g)	57.5g(with battery)	Dimension	72*27x25mm
	36.5g(without battery)	NMEA	GGA,GSA,GSV,RMC

1.4 Buttons and Description

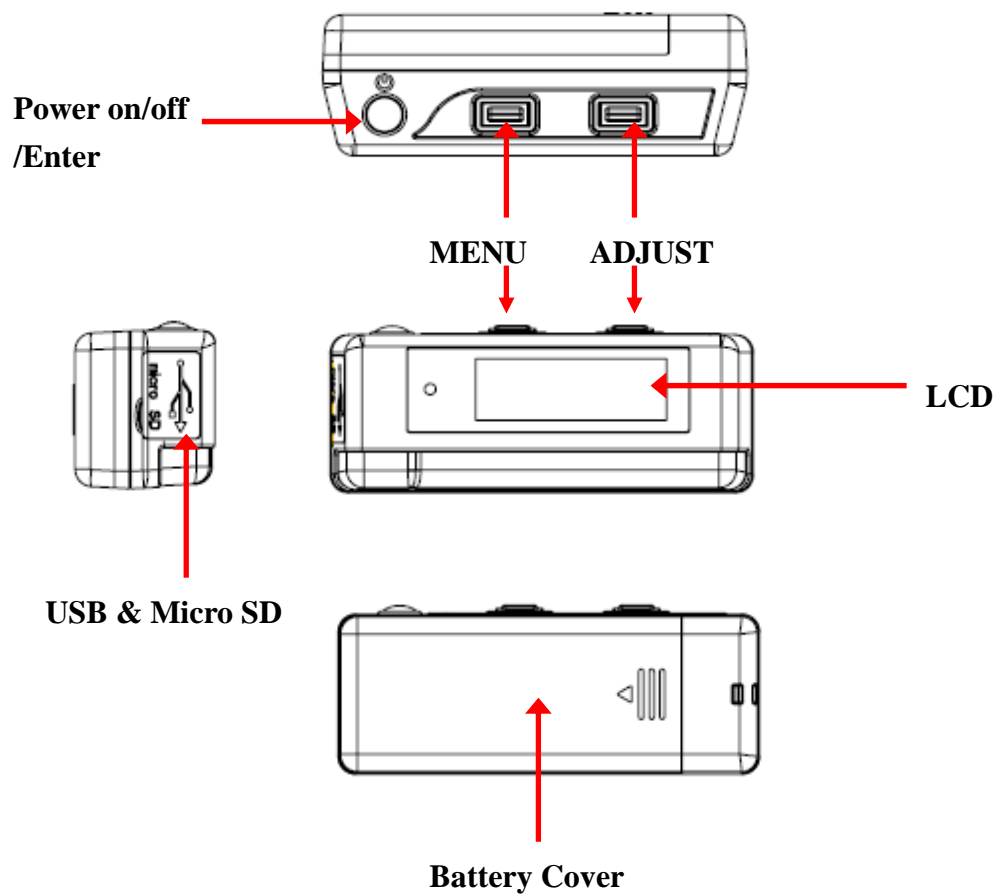

1.5 Accessories

Congratulations on your purchase of the TripMate850. Before you start using TripMate850, please make sure if your package includes the following items. If any item is damaged or missing, please contact your dealer at once.

- ⊙ Mini USB cable x1
- ⊙ AAA battery x2
- ⊙ Quick start guide x1
- ⊙ Strap x1
- ⊙ Micro SD card x1 (inside the TripMate850)

[Note] Unit package contents may vary depending on countries without prior notice.

Micro SD card compatible table

2G : Lexar 、KINGMAX 、Apacer
4G : Apacer 、KINGMAX
8G : Apacer

Chapter2. Getting Started

2.1 Turn on/off TripMate850

Before you start to use TripMate850 to log data, please check if Micro SD card is inside the TripMate850.

Press “POWER” button for 3 sec, LCD screen will show battery, satellite, log memory status.

POWER OFF

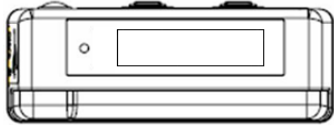

POWER ON

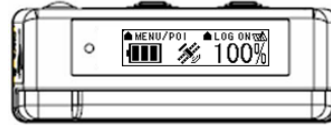
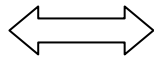

When Tripmate850 connects to PC/Laptop via USB cable, it works as a USB2.0 mass storage device (support **Window2000 above / MAC v8.5 above** operation system) and all function are inactive at this moment. It does not support G-mouse function via USB cable. Through USB cable, you are not able to charge TripMate850 but to download recorded data from device to PC/Laptop only.

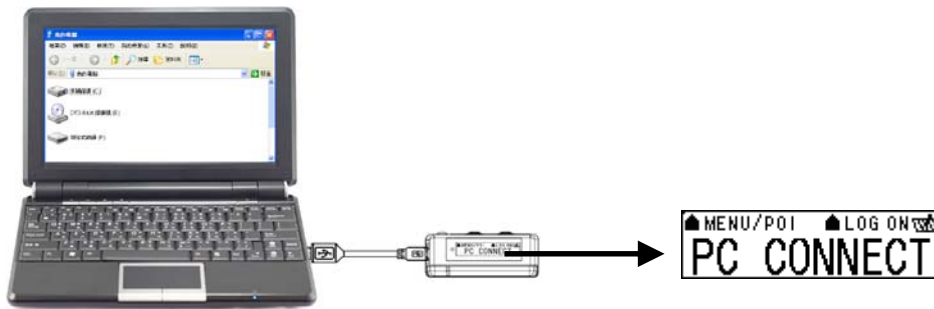

2.2 Main Flow

	Battery, Satellite, Log memory Mode
	Time Mode
	Position Mode
	Speed & Direction Mode
	Distance Measurement Mode
	Track back Mode
	Setting Mode

2.3 Flow Diagram

Please press “ENTER” button to confirm your selection of Menu item.

POWER/ENTER MENU ADJUST

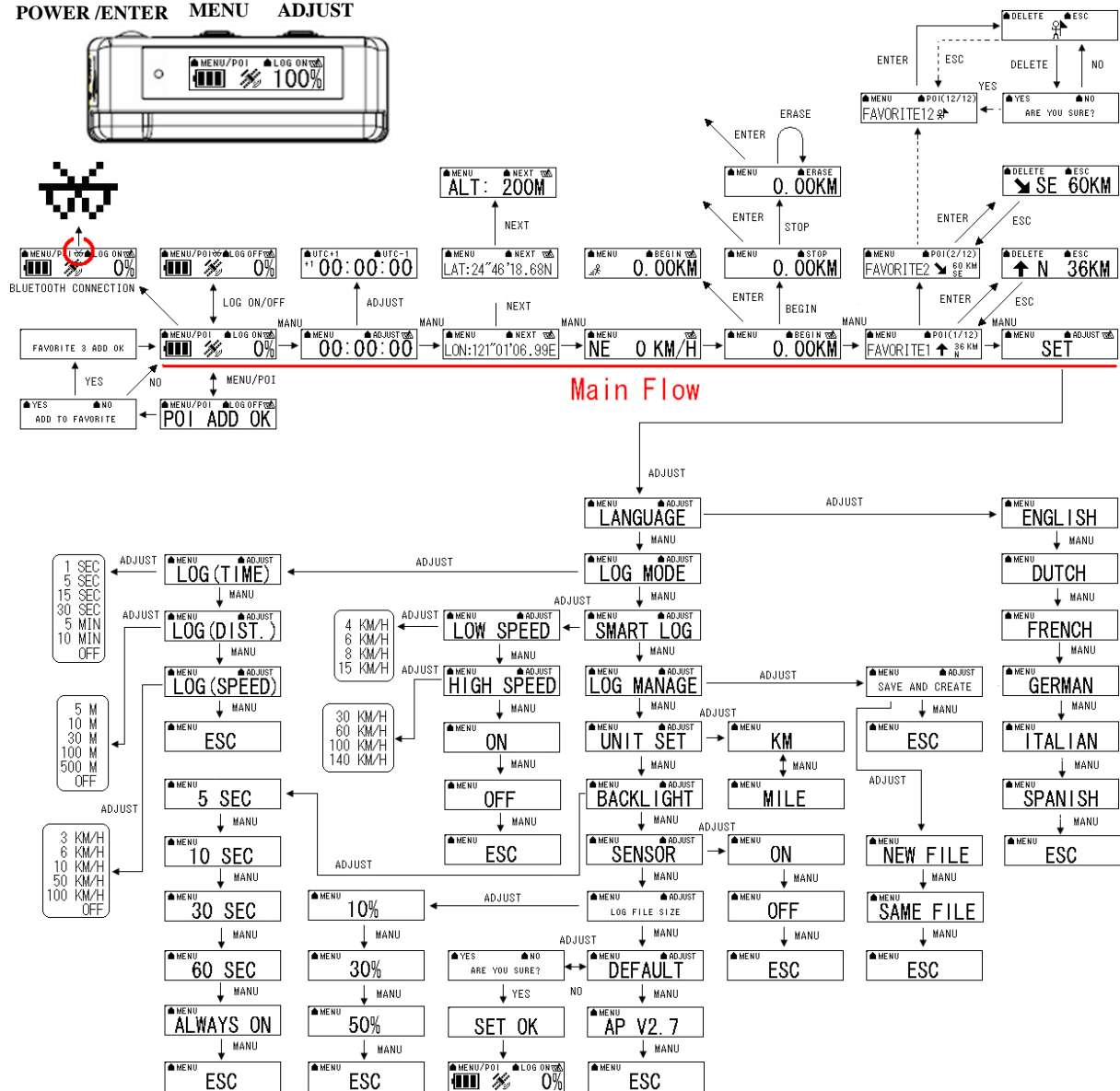

For detail information, please see functional description in section 2.5.

When TripMate850 does not have location fix, the screen will show below image.

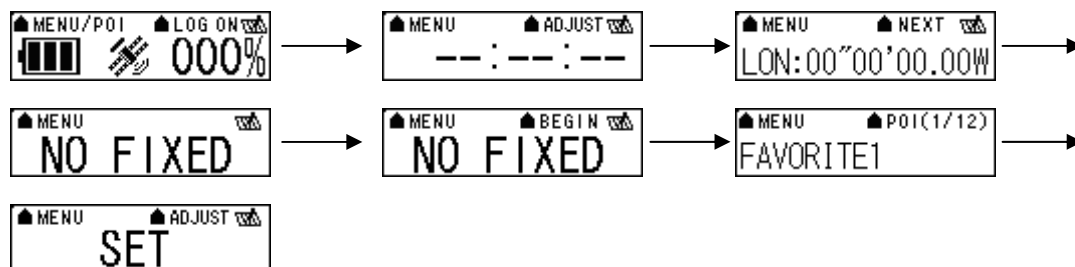







If there is no Micro SD card inside the TripMate850, the device will not be able to store logged data. The screen will show below image.

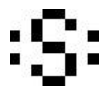

[Note] TripMate850 can be used as a mass storage device with Micro SD card inside.

2.4 ICON Introduction

Symbol	Category	Status	Function
	LOG	On	Device is not in log mode yet.
		Blinking	In LOG mode.
	BLUETOOTH	Off	Not yet connected to any Bluetooth device.
		Blinking	Bluetooth is connected for data transmission.
	SATELLITE	On	Acquiring satellite signal, GPS position not fixed.
		Blinking	GPS position fixed, ready for Log data and navigation with Smartphone/PDA.
	BATTERY	On	The battery capacity is full.
	BATTERY	On	Low battery.
	SMART LOG	On	Start smart log function.
		Off	Shut down smart log function.
	GOAL	On	Reach POI position which you have recorded as a favorite position in your POI list before. (Favorite1~Favorite12)
	Distance measurement	On	Begin distance measurement
		Off	Stop distance measurement

2.5 Functional description

2.5.1 Battery, Satellite, Log memory Mode

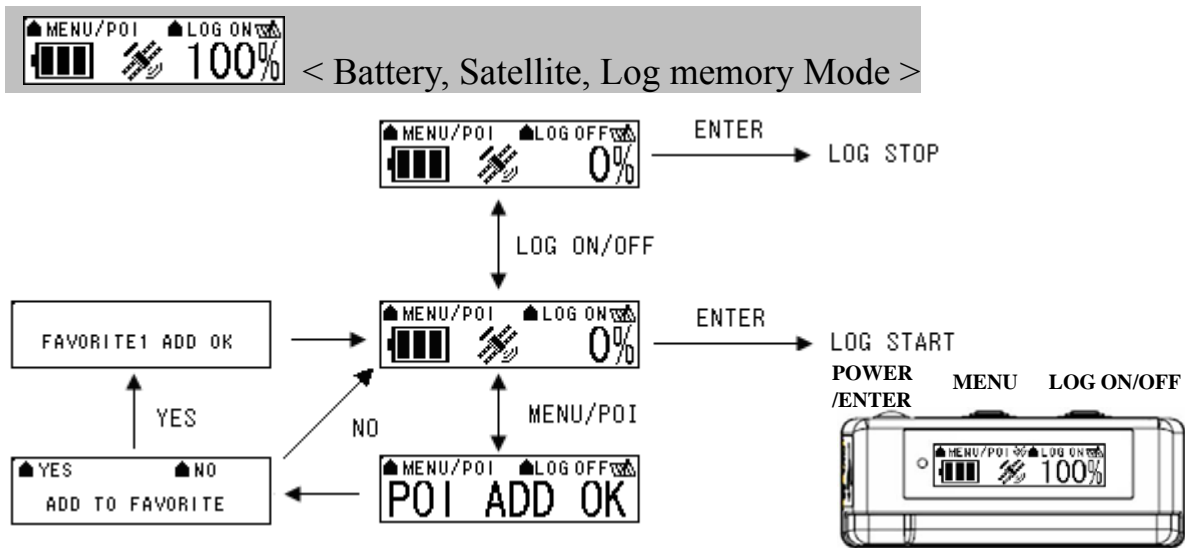

[Note] If the TripMate850 can not obtain GPS fix, it will be unable to record POI.

Function	Button	Detail Description
START LOG	LOG ON > ENTER	When you want to start log data, please check the upper right hand corner of the screen which is staying in "LOG ON", and the log icon is blinking 1 time / per second, which means it's in log mode.
STOP LOG	LOG OFF > ENTER	After you turn on the TripMate850, the screen will show log memory from 0% to 100%. When log memory increase to 100%, the TripMate850 will stop logging. If you want to stop logging data, please press "LOG ON/OFF" button to "LOG OFF" and then press "POWER" button.
POI (point of interest)	MENU/POI	Press "MENU/POI" button for 3 seconds, the TripMate850 will record POI and show "POI SET OK". After that the screen will show "Add to favorite?", you can select "YES" or "NO" to make your decision. If you select "YES", TripMate850 will record the POI as one of the 12 sets favorite position in your POI list. If you select "NO", TripMate850 will go back to main page.
NEXT SECTION	MENU	Press "MENU" button to next section.

2.5.2 Time Mode

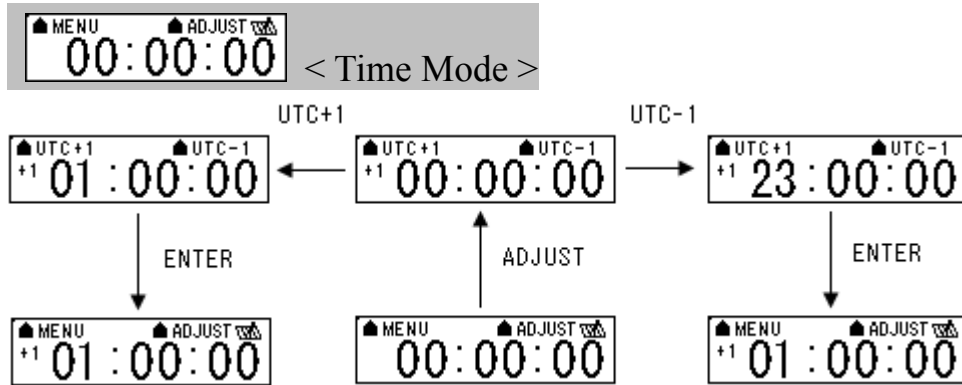

Function	Button	Detail Description
TIME ADJUSTMNET	ADJUST > UTC+1 or UTC-1 > ENTER	The time mode uses UTC time which receives from GPS ephemeris. You can set local time manually. After you press "ADJUST" button, the screen will show "UTC+1" and "UTC-1". When the time is adjusted successfully, please press "ENTER" button.
NEXT SECTION	MENU	Press "MENU" button to next section.

2.5.3 Position Mode

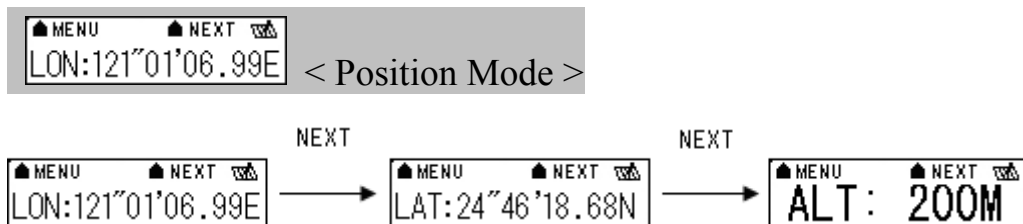

Function	Button	Detail Description
POSITION INFORMATION	NONE	When the GPS position is fixed, the TripMate850 will show longitude / latitude / altitude information on the screen.
NEXT SECTION	MENU	Press "MENU" button to next section.

2.5.4 Speed & Direction Mode

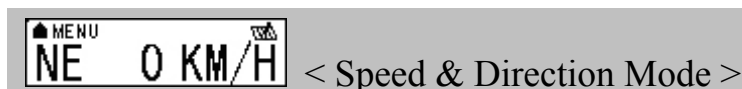

Function	Button	Detail Description
SPEED AND DIRECTION	NONE	In this mode, the TripMate850 will indicate current speed and direction on the screen.
NEXT SECTION	MENU	Press "MENU" button to next section.

2.5.5 Distance Measurement Mode

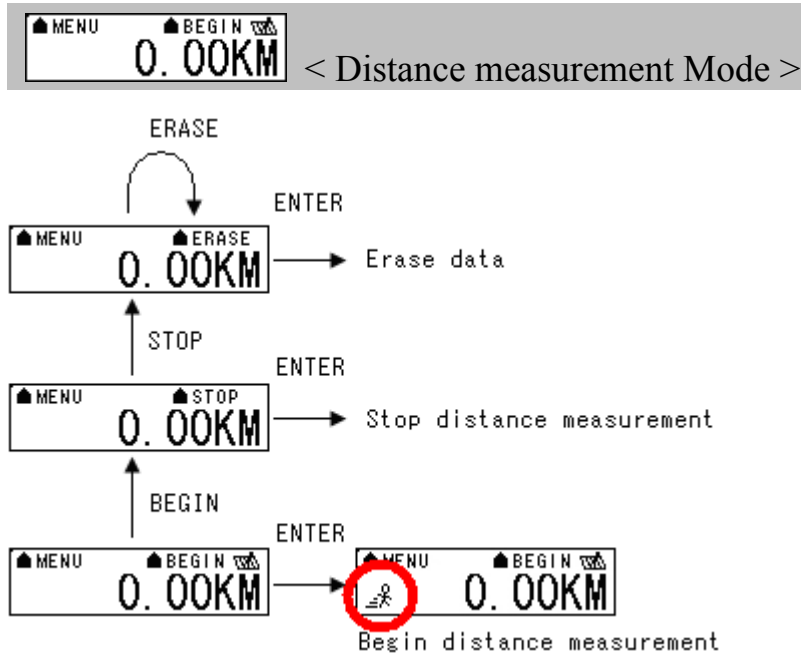

Function	Button	Detail Description
Begin distance measurement	BEGIN > ENTER	Select "BEGIN" among "BEGIN", "STOP", or "ERASE" function and press "ENTER" button, TripMate850 will start to measure distance.
Stop distance measurement	STOP > ENTER	Select "STOP" among "BEGIN", "STOP", or "ERASE" function and press "ENTER" button, TripMate850 will stop measuring distance.
Erase data	ERASE > ENTER	Select "ERASE" among "BEGIN", "STOP", or "ERASE" function and press "ENTER" button, TripMate850 will erase the measured distance data and the figure shown on the screen will return to zero.
NEXT SECTION	MENU	Press "MENU" button to next section.

2.5.6 Track Back to POI

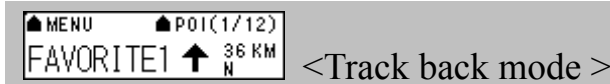

In this mode, the TripMate850 can track back to POI. According to the recorded favorite position in the POI list, TripMate850 will give you a reference direction and distance to tell you how far you're away from the POI position.

If you want to create a new POI into TripMate850, please press "MENU/POI" button for 3 seconds in main page, the device will show "POI ADD OK" and the screen will show "Add to favorite?". If you select "YES", TripMate850 will record the POI as one of the favorite position in your POI list. If you select "NO", TripMate850 will go back to main page.

Please be noticed that you are allowed to create 12 sets favorite position. If the favorite position is over 12 sets number, the TripMate850 will show "Favorite full" on the screen as a reminder. If you want to record one more new POI, please delete one of the 12 sets favorite positions to release the space for the storage of the new POI.

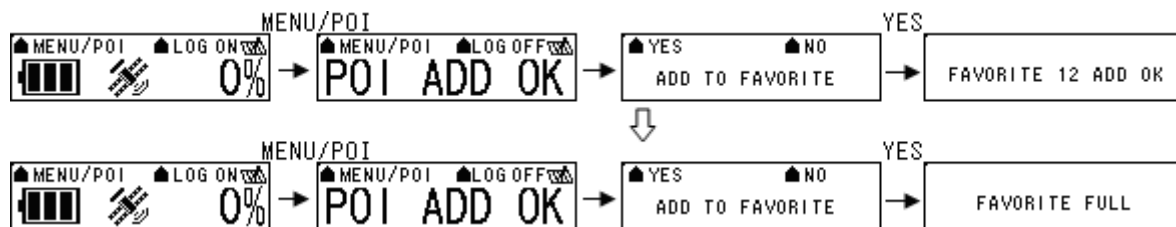

In addition, if you would like to track back to POI position, please go to "Find POI position mode" to choose one of the POI positions which you want to go back. If you arrive the POI position, the TripMate850 will show the icon "📍" to tell you that you have reached the POI.

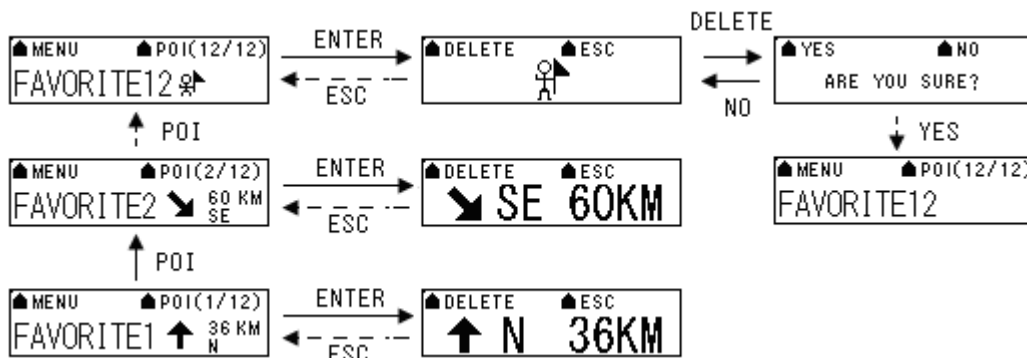

[Note] The maximum distance of the measured POI shown on the screen is 9999km. Therefore, if the distance between the POI and your current position is more than 9999km, the TripMate850 only show "9999km" on the screen maximally.

Function	Button	Detail Description
Track Back to POI mode	POI (* /12) > ENTER	You can select favorite position when press "POI (* /12)" button. Also you can press "ENTER" button to zoom in for clear view.
Delete POI position	POI (* /12) > ENTER > DELETE	All the favorite position can be deleted in this mode.
NEXT SECTION	MENU	Press "MENU" button to next section.

2.5.7 Setting Mode

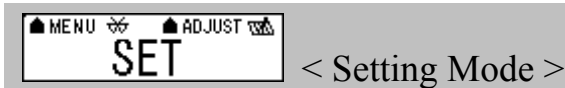

Function	Button	Detail Description
FURTHER SET	ADJUST	Press “ADJUST” button to go to option of the setting mode. In “SET” mode, there are “LANGUAGE”, “LOG MODE”, “SMART LOG”, “LOG MANAGE”, “UNIT SET”, “BACKLIGHT”, “SENSOR”, “LOG FILE SIZE”, and “DEFAULT”, which allow you for further setting.
NEXT SECTION	MENU	Press “MENU” button to next section.

2.5.7.1 Several Language Setting

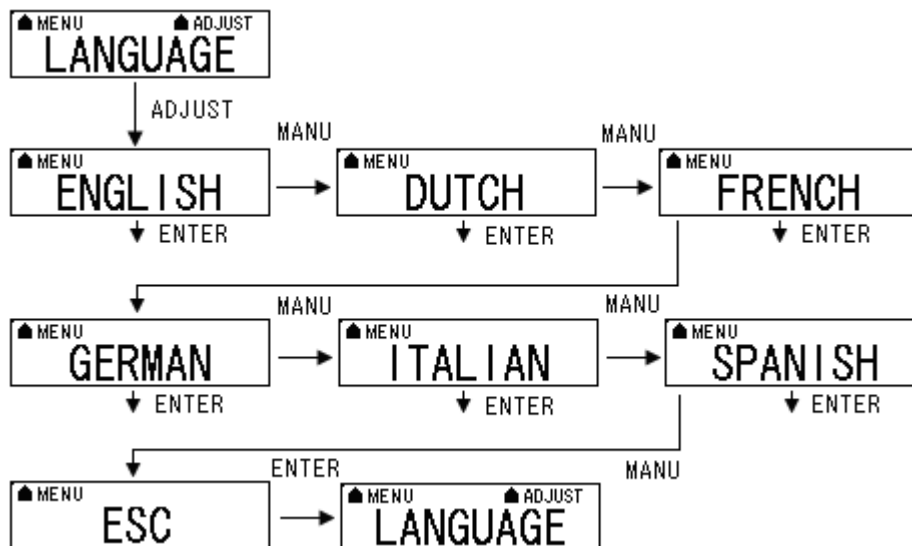

Function	Button	Detail Description
LANGUAGE SETTING	ADJUST > MENU (TO YOUR LANGUAGE) > ENTER	Please press “ADJUST” button, and then press “MENU” button to select several language selections. When you make sure your selection, please press “ENTER” button.
NEXT SECTION	MENU	Press “MENU” button to next section.
Go back to language	MENU (TO ESC) > ENTER	When you jump to “ESC” and then press “ENTER” button, the TripMate850 will go back to “LANGUAGE” mode.

2.5.7.2 Log Mode Setting



In log mode, you can set log criteria by time, distance or speed. Please press “ADJUST” button and then press “MENU” button to select different setting of log criteria. When you make sure your selection, please press “ENTER” button to save the log criteria.

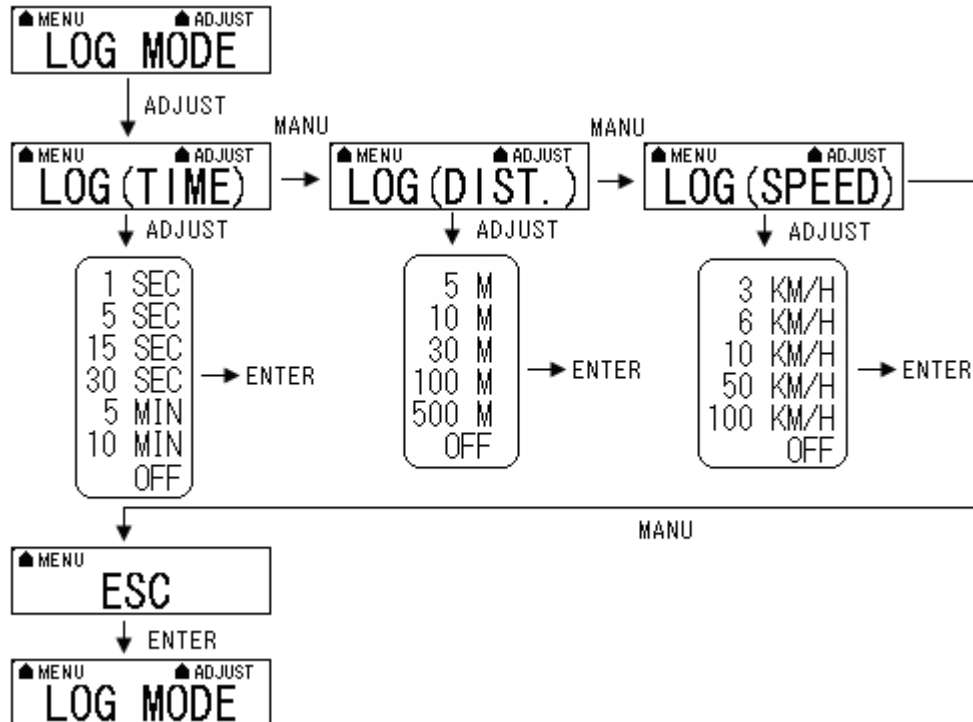

Function	Button	Detail Description
LOG BY TIME	ADJUST > ENTER	In log time mode, the TripMate850 can set log criteria from following options, to log one time every 1 second / 5 seconds / 15 seconds / 30 seconds / 5 minutes / or 10 minutes. When you make sure your selection, please press “ENTER” button.
LOG BY DISTANCE	ADJUST > ENTER	In log distance mode, the TripMate850 can set log criteria from following options, to log one time every 5 meters / 10 meters / 30 meters / 100 meters / or 500 meters. When you make sure your selection, please press “ENTER” button.
LOG BY SPEED	ADJUST > ENTER	In log speed mode, the TripMate850 can set log criteria from following options, to log one time when speed is over than 3km/h / 6km/h / 10km/h / 50km/h / or 100km/h. When you make sure your selection, please press “ENTER” button.
GO BACK TO LOG MODE	MENU (to ESC) > ENTER	When you jump to “ESC” and then press “ENTER” button, the TripMate850 will go back to “LOG” mode.
NEXT SECTION	MENU	Press “MENU” button to next section.

[Note] TripMate850 can not support 5Hz log feature.

2.5.7.3 Smart Log Setting



When the smart log function is on, the TripMate850 will go into different log manner which depends on speed per hour. And the screen will show “S” icon.

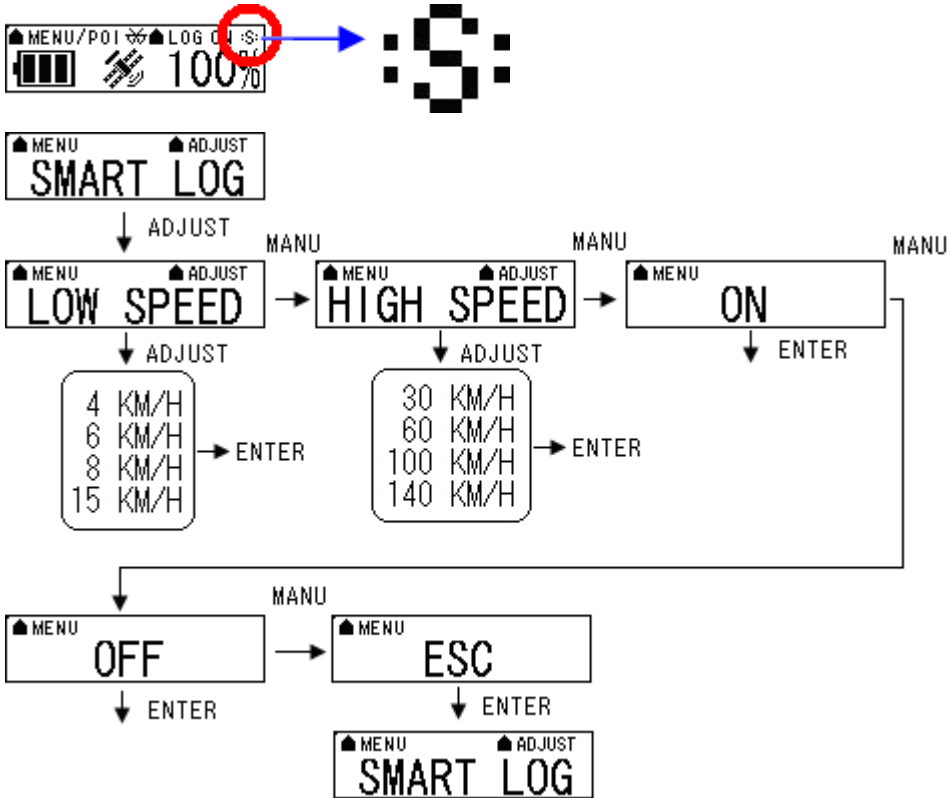

Function	Button	Detail Description
LOW SPEED	MENU (to LOW SPEED) > ADJUST > ENTER	In low speed, please press “ADJUST” button, and then press “MENU” button to select 4km/h, 6km/h, 8km/h, or 15km/h. When you make sure your selection, please press “ENTER” button.
HIGH SPEED	MENU (to HIGH SPEED) > ADJUST > ENTER	In high speed, please press “ADJUST” button, and then press “MENU” button to select 30km/h, 60km/h, 100km/h or 140km/h. When you make sure your selection, please press “ENTER” button.
START SMART LOG FUNCTION	MENU (to ON) > ENTER	When it shows “On” on the screen, press “MENU” button, the TripMate850 will start smart log function. And it will show "s" icon on the upper right hand corner of the screen.
STOP SMART LOG FUNCTION	MENU (to OFF) > ENTER	When it shows “Off” on the screen, press “MENU” button, the TripMate850 will stop smart log function.
GO BACK TO SMART LOG	MENU (to ESC) > ENTER	When you jump to “ESC” and then press “ENTER” button, the TripMate850 will go back to “SMART LOG” mode.
NEXT SECTION	MENU	Press “MENU” button to next section.



When you select “ON” and then press “ENTER” button, please see below description.

> 6km/h (LOW SPEED)	Log 1 time / per 15 sec
60>Middle SPEED>6km/h	Log 1 time / per 10 sec
60km/h (HIGH SPEED) >	Log 1 time / per 5 sec

2.5.7.4 Log Manage Setting

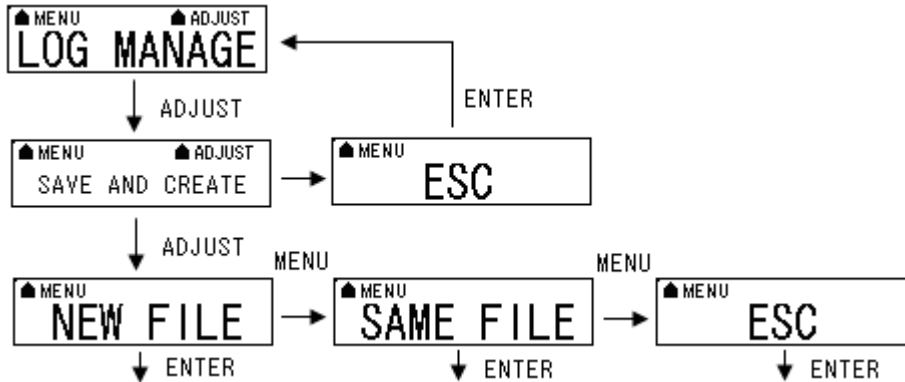

If you want to create a new track, you can press “ADJUST” button to “save and create” function.

In “save and create” mode, there are two options:



→ To save current track and create another track in new file.



→ To save current track and create another track in same file.
And TripMate850 will stop logging.

Function	Button	Detail Description
Create new track and save in new file.	ADJUST > ADJUST (to NEW FILE) > ENTER	In “SAVE AND CREATE” mode, please press “ADJUST” button, it will show “NEW FILE”, if you want to save current track and create another track in new file., please press “ENTER” button.
Create new track and save in same file & stop logging	ADJUST > ADJUST > MANU (to SAME FILE) > ENTER	In "SAME FILE" mode, if you want to save current track and create another track in same file, please press “ENTER” button. And also TripMate850 will stop logging.
Go back to LOG MANAGE	MENU (to ESC) > ENTER	When you jump to “ESC” and then press “ENTER” button, the TripMate850 will go back to “LOG MANAGE” mode.

2.5.7.5 Unit Set

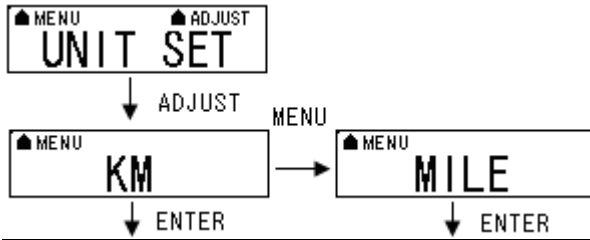

Function	Button	Detail Description
Unit setting	ADJUST > MENU (to KM or MILE) > ENTER	In “Unit setting” mode, please press “ADJUST” button, and then press “MENU” button to select “km” or “mile” as unit of measurement for the TripMate850. When you make sure your selection, please press “ENTER” button, and the TripMate850 will go back to “Unit setting” mode.
NEXT SECTION	MENU	Press “MENU” button to next section.

2.5.7.6 Backlight Set

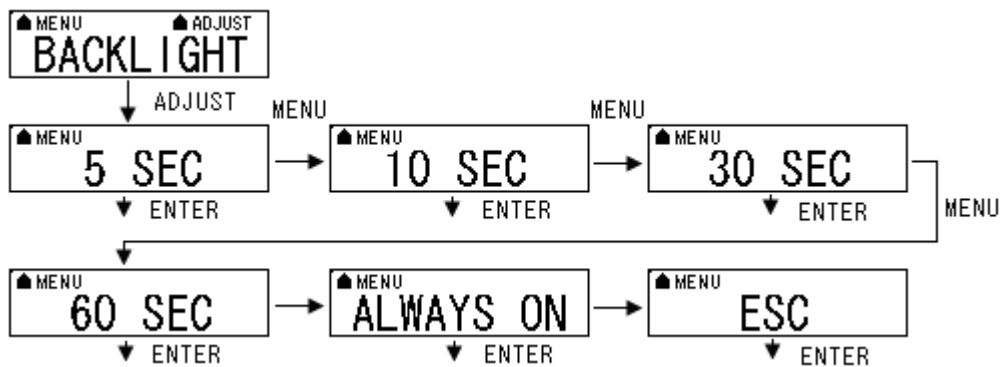

Function	Button	Detail Description
Backlight setting	ADJUST > MENU (to 5 SEC, 10 SEC, 30 SEC, 60 SEC, ALWAYS ON) > ENTER	Please press “ADJUST” button and then press “MENU” button to select time-out setting for backlight. You can set backlight time-out in 5 sec / 10 sec / 30 sec / 60 sec / Always on. When you make sure your selection, please press “ENTER” button, and the TripMate850 will go back to “Backlight” setting mode.
NEXT SECTION	MENU	Press “MENU” button to next section.

2.5.7.7 Sensor Set

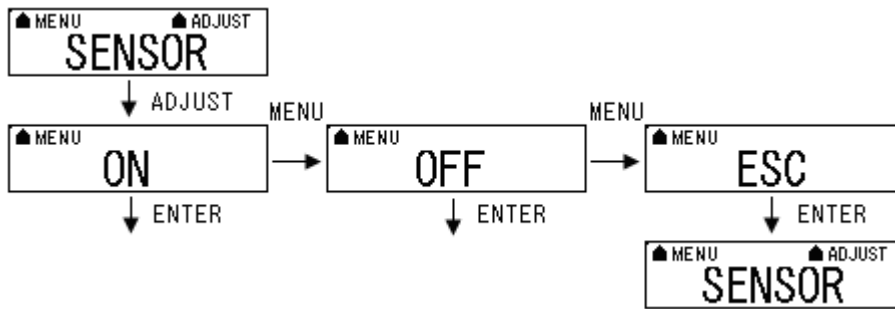

Function	Button	Detail Description
Vibration sensor setting	ADJUST > MENU (to ON or OFF) > ENTER	Please press “ADJUST” button and then press “MENU” button to select “On” or “Off” for vibration sensor setting. When you make sure your selection, please press “ENTER” button. When you enable the sensor function, without moving the TripMate850 for ten minutes, the device will go into power saving mode, shut down screen and stop logging data. After you move the TripMate850, it will start log again.
NEXT SECTION	MENU	Press “MENU” button to next section.

2.5.7.8 Log File Size Set

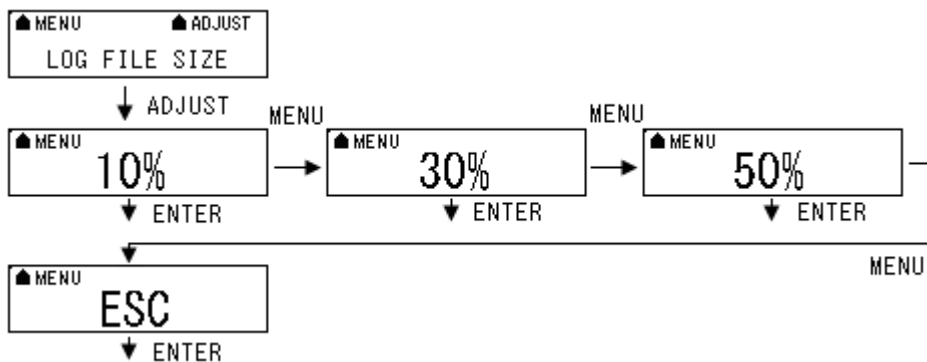

Function	Button	Detail Description
Memory size setting	ADJUST > MENU (to 10%, 30% or 50%) > ENTER	Please press “ADJUST” button and then press “MENU” button for selection. You can set 10%, 30% or 50% of total memory size for storing log data. When you make sure your selection, please press “ENTER” button.
NEXT SECTION	MENU	Press “MENU” button to next section.

2.5.7.9 Default Set



Function	Button	Detail Description
Recover to default	ADJUST > YES or NO	Please press “ADJUST” button and it will show “Are you sure?”, if you select “YES”, the screen will show “SET OK”. And the TripMate850 will recover to default setting and go back to Battery, Satellite, Log memory mode. If you select “NO”, the TripMate850 will go back to “DEFAULT” mode.
NEXT SECTION	MENU	Press “MENU” button to next section.
Go back to setting mode	MENU (to ESC)> ENTER	When you jump to “ESC” and then press “ENTER” button, the TripMate850 will go back to “Setting” Mode.
NEXT SECTION	MENU	Press “MENU” button to next section.

2.5.7.10 AP VERSION

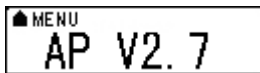

Function	Button	Detail Description
AP version	MENU	You can see current AP version of this device. And you are available to update AP version to enjoy new features just like our upgrade version. (Please refer to 2.6 AP upgrade)
NEXT SECTION	MENU	Press “MENU” button to next section.

2.5.8 Connecting with your handheld device

Please refer to the user manual of PDA/Smartphone to enable the Bluetooth connectivity. Below, we provide a common procedure of software installation to set up your PDA/Smartphone. (For other PDA/Smartphone, the steps may be different. Bluetooth Manager is a popular program used on Bluetooth device.)



Start -> Bluetooth Manager

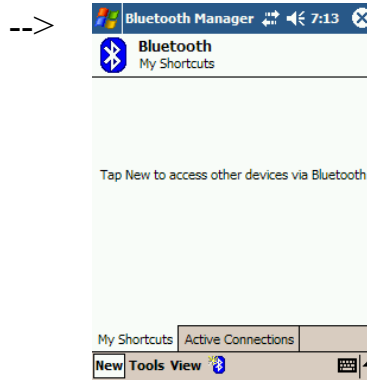

New

A. Open “Bluetooth Manager” on your pocket pc, and establish a new connection.



Explore a Bluetooth device
->Next



Tap 850 GPS

B. Explore a Bluetooth device, and find the “850 GPS”



Passkey 0000 (if your PDA asks for the passkey)

C. (Optional)



Select SPP slave->Next



Finish

D. Connect to Serial Port Profile (SPP) Slave

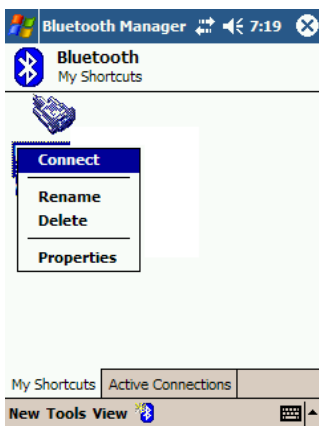

Tap and Hold 850 GPS
: SPP slave, Connect



Done

E. Finish Bluetooth Manager Setup

1. Loading your GPS mapping or routing software

You should have mapping software on your PDA/ Smartphone/ laptop or you need to install it before using the TripMate850 for navigation.

2. Starting the application

Select the correct COM port & baud rate within the application.

[Note] The Bluetooth device in most of the applications has an “auto-detect” feature so that you do not need to select the Baud Rate.

2.6 AP upgrade

TripMate850 is feasible to update its device AP manually by yourself. Through this service, you can get and enjoy new features just like our upgrade version.

Please follow below steps to upgrade AP for TripMate850.

Step1. Please download latest AP file from TripMate850 product page of TSI website.

<http://www.transystem.com.tw/product.php?b=G&m=pe&cid=4&sid=21&id=56>

Step2. Build a connection between TripMate850 and PC/Laptop via USB cable, the TripMate850 will work as mass storage.

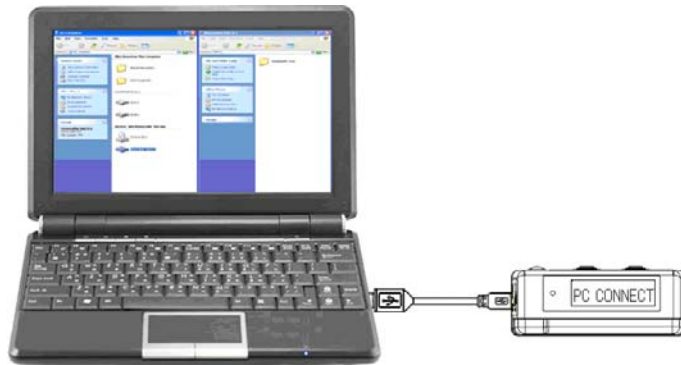

Step3. Put the AP file inside micro SD card.

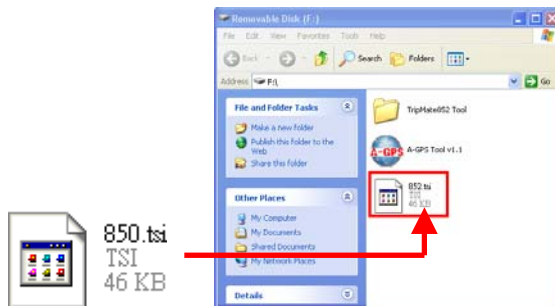

Step4. After complete above steps, please TURN OFF TripMate850.

And please press “ADJUST” button and then press “ENTER” button, the TripMate850 will update its AP.

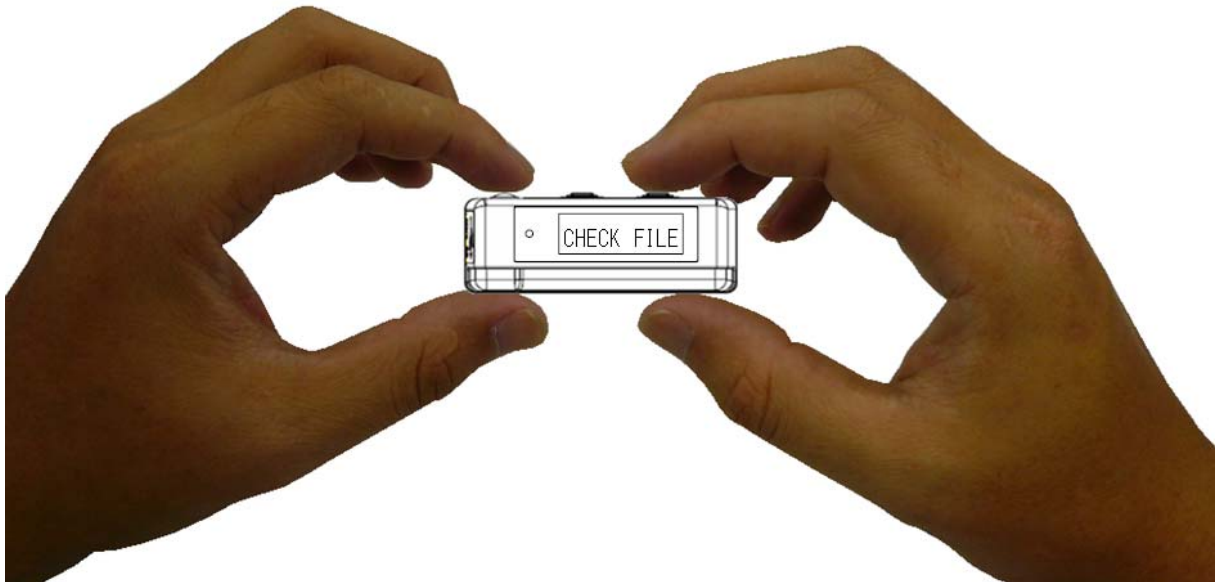

Step5. During the AP upgrade procedure, the TripMate850 will check file first to detect if there is a “AP file” inside micro SD card. At this moment it will show “CHECK FILE” on the screen. After that TripMate850 will start to upgrade its AP, and it will show “UPDATING” on the screen. When the AP upgrade procedure is complete, it will show “UPDATE OK”. Afterward the screen will shut down and TripMate850 will turn off automatically. TripMate850 upgrade its AP successfully.



2.7 Helpful Tips

- It's better to turn off the TripMate850 when you don't use it, or the serial Flash's life can't last long.
- Some vehicles having heavy metallic sun protecting coating on windshields may affect GPS signal receptions
- Driving in and around high buildings may affect GPS signal receptions.
- Driving in tunnels or indoor parking may affect signal reception.
- In general, any GPS receiver performs best in open space where it can see clean sky. Also weather will affect GPS reception – rain & snow contribute to worse sensitivity.
- Low battery of PDA or TripMate850 may affect signal reception.
- Please check the correct “COM” and “Baud rate” of your PDA.
- TripMate850 output data every second, therefore the actual position and the position shown in your map may have slight time delay. This may happen when you drive at high speed or make a turn around a corner.
- TripMate850 may not work indoors where it can not see the sky.
- For the 1st time you use TripMate850, it will take 1 to 3 minutes to obtain the satellite constellation information and fix your position, this is called “Cold Start”. If you replace the battery, TripMate850 will do Cold Start again.
- If your TripMate850 can't fix your position for more than 20 minutes, we suggest you change to another spot with open space and then try again.

Chapter3. How to configure your GPS Record?

The GpsView program only supports the Microsoft Windows based platform. Before you start to use GpsView software, it only supports use of Bluetooth connection between your PC and TripMate850.

3.1 GpsView software

Open the GpsView software, please select correct COM port and Baud Rate (Bluetooth: 115,200 bps) to configure GPS.

3.1.1 Using GpsView Program

Click “Command” tap. Update Rate 1 ~ 5Hz is user configurable. And still more options for choice of NMEA output, DGPS...etc. all available through pull-down menus.

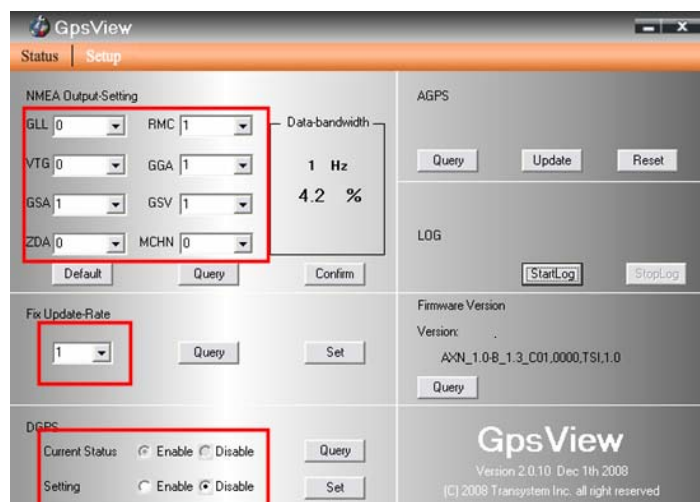

3.2 Download AGPS

Please power on TripMate850 and build a connection between your PC and TripMate850 via USB cable, see below:



1. Execute **AGPS Tool.exe** in Micro SD Card directly
→ AGPS download window will pop-up

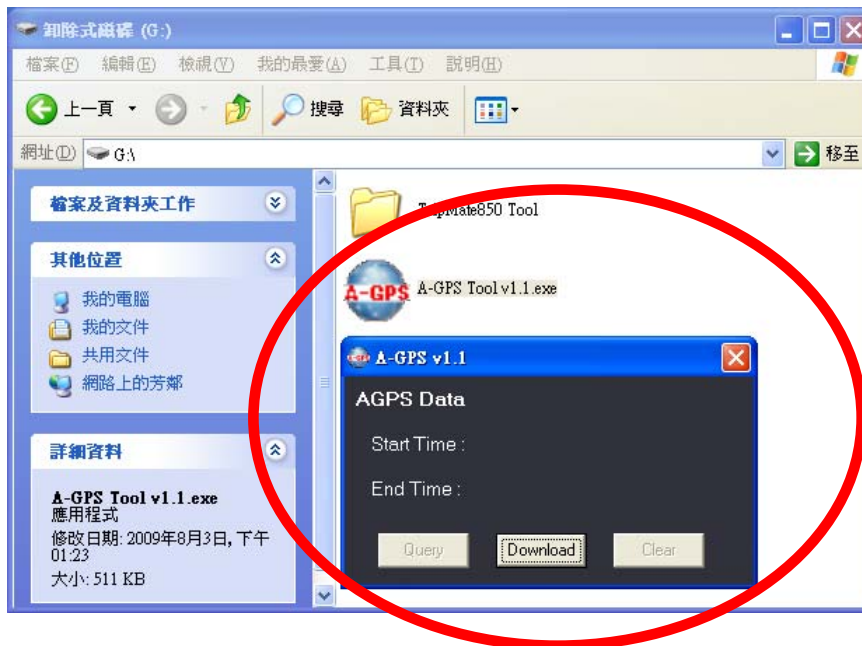

2. click **Download**
→ downloading AGPS data into Micro SD card

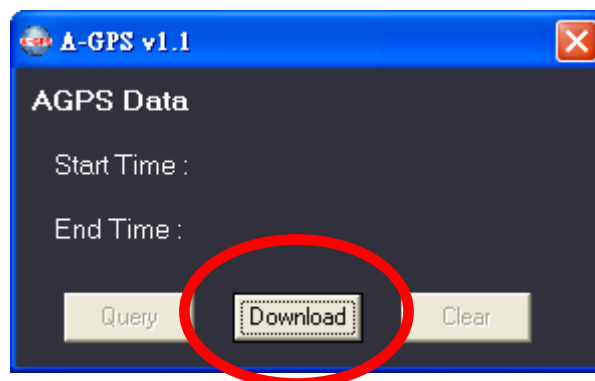

3. EPO file will be created in Micro SD card when successfully download AGPS data

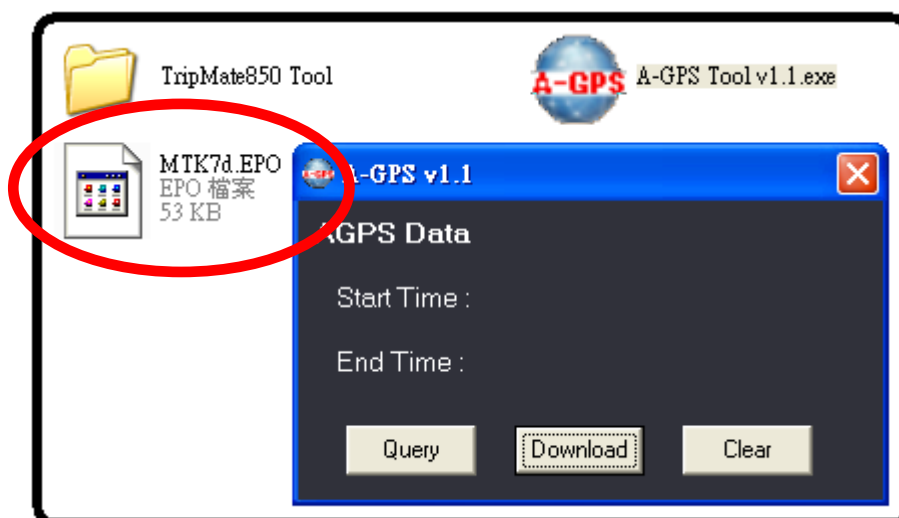

4. Power off TripMate850 → Power on TripMate850

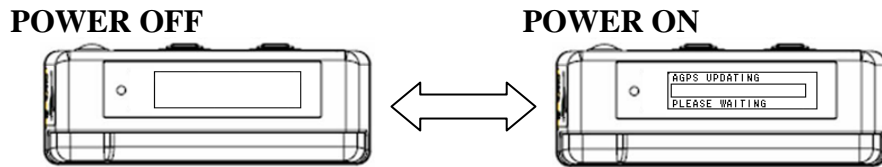

5. A processing bar will show up and TripMate850 start to update AGPS, it will show “AGPS updating” on the screen. When it shows “Update OK” on the screen, AGPS update process is complete.

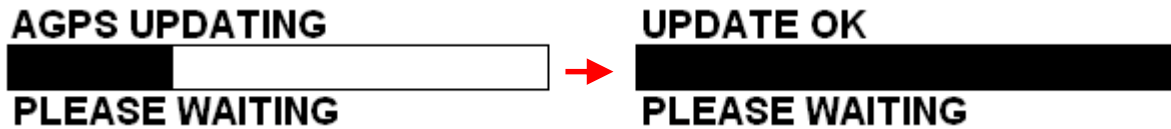

6. EPO file will be deleted automatically after AGPS updating. → Complete AGPS download and updating.

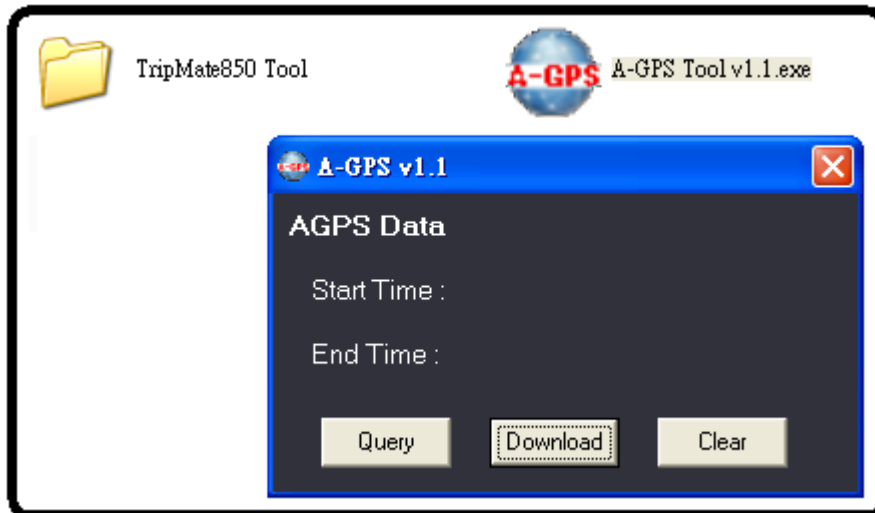

[Note and Warning] Please DO NOT move the EPO file to other place, just remain it in the Micro SD card after downloading. Then, the EPO file which includes AGPS data can be applied by TripMate850 successfully. AGPS data has six days time limited.

Chapter4. Using Photo Tagger software

4.1 Execute and install software utility Photo Tagger

Complete GPS Photo Tagger installation

4.2 Google Earth

If your computer is not yet installed with Google Earth, Google Earth has free download version, go download it in the internet first. For more information, please visit <http://earth.google.com/>

4.3 Software Utility - TripMate850

For further function to use the Photo Tagger software in detail, please refer to Photo Tagger user manual:

Photo Tagger software > Help > User Manual

To use a mini-USB cable to connect the TripMate850 to your PC, you have to power on the TripMate850 unit.

Chapter5. Power description

Please be noticed that the operation time of TripMate850 will depend on the battery type you use. In normal condition, we suggest use alkaline battery for TirpMate850 because alkaline battery is able to contribute longer operation time which last up to 12 hours.

The following is the reference operation time table of diverse AAA battery for TripMate850.

	Temperature (Typical)
Alkaline battery	12 hours
Rechargeable battery	11 hours
Dry battery	4 hours

Appendix A. Locr GPS Photo

With TripMate850 and locr GPS Photo software, users are allowed to import geotagging adds information to photos. The position (latitude/ longitude) then be written into the EXIF header for the further application. Also, locr GPS Photo can integrate travel log and digital photos by date/ time to show photos on the map directly.

Please find the installation file for Windows XP/ Vista in Micro SD card, or go to <http://www.locr.com> for further information.

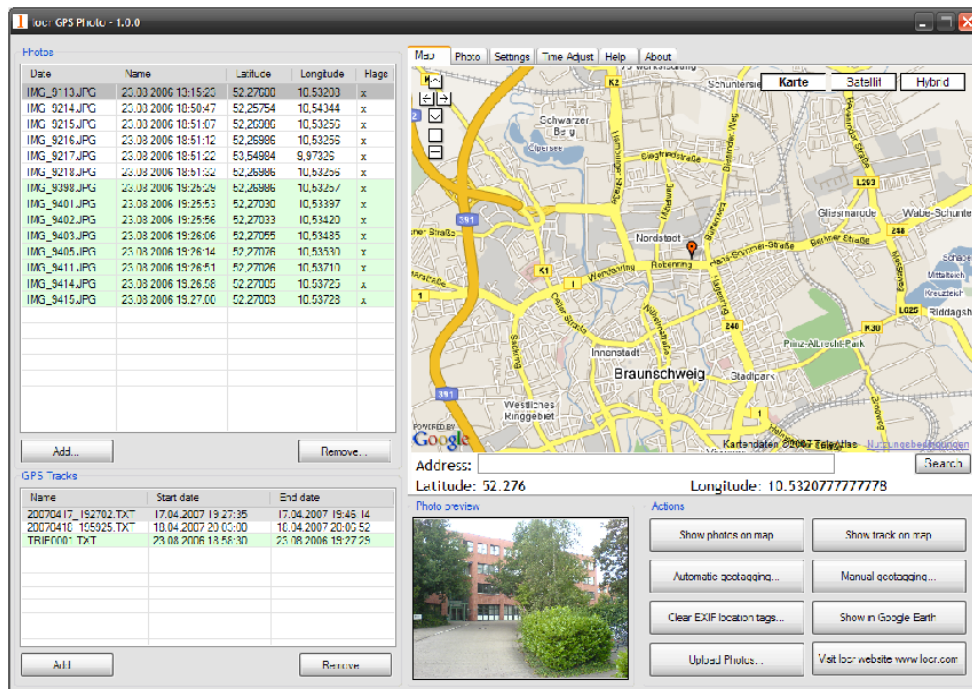

Appendix B. Certification

FCC Notice

This device complies with part 15 of the FCC rules. Operation is subject to the following two conditions:

1. This device may not cause harmful interface, and
2. This device must accept any interference received, including interference that may cause undesired operation.

FCC RF Exposure requirements:

This device and its antenna(s) must not be co-located or operation in conjunction with any other antenna or transmitter.

NOTE: THE MANUFACTURER IS NOT RESPONSIBLE FOR ANY RADIO OR TV INTERFERENCE CAUSED BY UNAUTHOURIZED MODIFICATION TO THIS EQUIPMENT. SUCH MODIFICATIONS COULD VOID THE USER'S AUTHORITY TO OPERATE THE EQUIPMENT.

CE Notice

CE 0984 

Is herewith confirmed to comply with the requirements set out in the Council Directive on the Approximation of the Laws of the Member States relating to Electromagnetic Compatibility (89/336/EEC), Low-voltage Directive (73/23/EEC) and the Amendment Directive (93/68/EEC), the procedures given in European Council Directive 99/5/EC and 89/336/EEC.

The equipment was passed. The test was performed according to the following European standards:

- EN 300 328-2 V.1.2.1 (2001-08)
- EN 301 489-1 V.1.4.1 (2002-04) / EN 301 489-17 V.1.2.1 (2002-04)
- EN 50371: 2002
- EN 60950: 2000

Appendix C. Warranty Information

Thank you for your purchase of GPS product from the company.

The company warrants this product to be free from defects in materials and workmanship for one year from the date of purchase. The warranty for accessories is six months. The stamp of distributor or a copy of the original sales receipt is required as the proof of purchase for warranty repairs. The company will, as its sole option, repair or replace any components, which fail in normal use. Such repair or replacement will be made at no charge to the customer for parts or labor. The customer is, however, responsible for any transportation costs.

This warranty does not cover failures due to abuse, misuse, accident or unauthorized alteration of repairs. The company assumes no responsibility for special, incidental punitive or consequential damages, or loss of use.